

---

INTER DYNE SYSTEMS, INC.  
**RETAIL PRICE LIST**  
**JANUARY 2012**

---

**TABLE OF CONTENTS**

---

<b>Pegboards: Pgs. 2-5</b>	
"V" & "B" Pegboards	Pg. 2
Acrylic & Epoxy Pegboards	Pg. 3
Pegboard Accessories	Pg. 3
Specialty Pegs	Pg. 4
Accessory Packages	Pg. 5
<b>Drip Troughs</b>	<b>Pg. 6</b>
<b>Screen Inserts &amp; Drain Grids</b>	<b>Pg. 7</b>
<b>Mounting Hardware</b>	<b>Pg. 7</b>
<b>Carboy Shelves</b>	<b>Pg. 8</b>
<b>Adjustable Racking Systems</b>	<b>Pg. 9</b>
<b>Shelving: Pgs. 9-13</b>	
Wall Shelves	Pg. 9,10
Standards, Brackets	Pg. 11
HD Standards, Brackets	Pg. 12
Discovery Shelving	Pg. 13
<b>Narcotics Cabinets</b>	<b>Pg. 14</b>
<b>Counter Tops/Tables</b>	<b>Pg. 15</b>
<b>Contact &amp; Order Information</b>	<b>Pg. 16</b>

---



**“V” VICTORIA MOD-RACK PEGBOARDS WITH DRIP TROUGHS AND CATCH DRAINS**

All “V” models come complete with integral drip trough, wall mount bracket, white standard 6” pegs and clear plastic tubing.

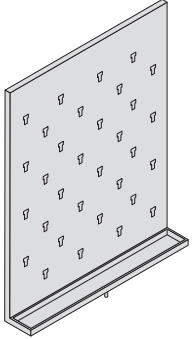
	MODEL NO.	SIZE WxH	NO. OF PEGS	SHIPPING WT.	RETAIL PRICE
 <p>Standard with 4" drip trough, 2" drip trough available upon request.</p>	V1824	18" x 24"	15	13 lbs.	294.00
	V1830	18" x 30"	24	14 lbs.	343.00
	V2418	24" x 18"	16	13 lbs.	316.00
	V2424	24" x 24"	20	16 lbs.	367.00
	V2430	24" x 30"	32	19 lbs.	387.00
	V2436	24" x 36"	40	21 lbs.	478.00
	V3024	30" x 24"	25	20 lbs.	436.00
	V3030	30" x 30"	50	24 lbs.	440.00
	V3036	30" x 36"	40	23 lbs.	470.00
	V3624	36" x 24"	30	21 lbs.	468.00
	V3630	36" x 30"	60	23 lbs.	498.00
	V3636	36" x 36"	66	25 lbs.	582.00
	V4824	48" x 24"	40		571.00
	V4830	48" x 30"	48		687.00
V4836	48" x 36"	88		825.00	

**“B” BARON MOD-RACK PEGBOARDS WITH DRIP DEFECTOR**

All “B” models come complete with wall mount bracket and white standard 6” pegs.

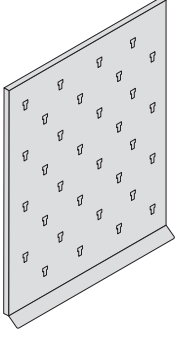
	MODEL NO.	SIZE WxH	NO. OF PEGS	SHIPPING WT.	RETAIL PRICE
	B2430	24" x 30"	32	14 lbs.	284.00
	B3030	30" x 30"	50	17 lbs.	316.00
	B3630	36" x 30"	50	21 lbs.	366.00

Custom sizes available, 3/4" thick is standard, 1" available upon request.

ACRYLIC PEGBOARDS

MODEL NO.	SIZE WxH	NO. OF PEGS	RETAIL PRICE
APB-1824	18" x 24"	16	319.00
APB-2424	24" x 24"	25	404.00
APB-2436	24" x 36"	39	473.00
APB-3024	30" x 24"	33	439.00
APB-3030	30" x 30"	41	473.00
APB-3036	30" x 36"	50	507.00
APB-3624	36" x 24"	39	473.00
APB-3630	36" x 30"	50	507.00
APB-3636	36" x 36"	61	581.00
APB-4830	48" x 30"	68	709.00
APB-6030	60" x 30"	33	898.00
APB-6033	60" x 33"	39	925.00
APB-6633	66" x 33"	44	966.00

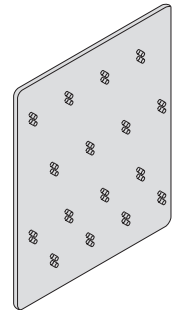

EPOXY PEGBOARDS

MODEL NO.	SIZE WxH	NO. OF PEGS	RETAIL PRICE
EPB-1824	18" x 24"	21	209.00
EPB-2424	24" x 24"	28	270.00
EPB-2430	24" x 30"	39	369.00
EPB-3024	30" x 24"	39	369.00
EPB-3030	30" x 30"	46	448.00
EPB-3036	30" x 36"	59	556.00
EPB-3630	36" x 30"	60	562.00
EPB-3636	36" x 36"	68	653.00

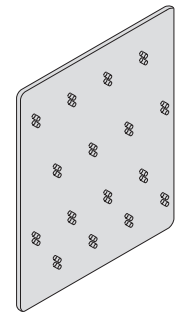

ACCESSORIES

MODEL NO.	DESCRIPTION	SHIPPING WT.	RETAIL PRICE
0210	Paper Towel Dispenser	6 lbs.	82.50
0215	Paper Towel Dispenser-Petite	4 lbs.	82.50
0342	Liquid Soap Dispenser-Horizontal	2 lbs.	75.00
0343	Liquid Soap Dispenser-Vertical	2 lbs.	75.00
GD-10	Glove Box Dispenser	2 lbs.	69.00
DS-12	Drain Shelf	1 lbs.	63.00
PR-12	Pipette Rack	2 lbs.	63.00
CY-12	Cylinder Yolk	2 lbs.	63.00
FH-6	Flask Holder	2 lbs.	41.25
FR-12	Funnel Rack	1 lbs.	63.00
DB-6	Drain Basket- 6" long	1 lbs.	41.25
DB-12	Drain Basket- 12" long	2 lbs.	63.00

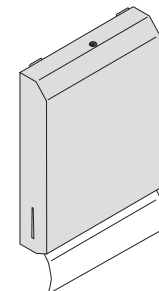

0210

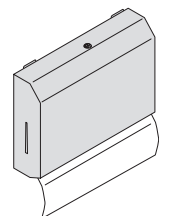

0215

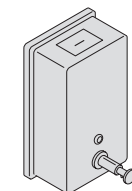

0343

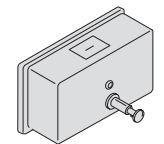

0342

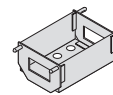

DB-6

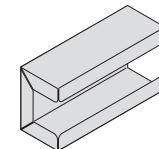

GD-10

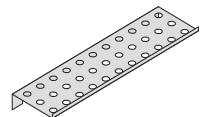

DS-12

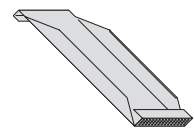

PR-12

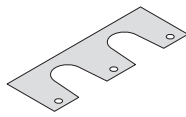

CY-12

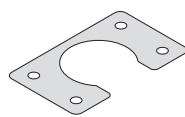

FH-6

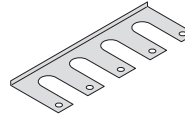

FR-12

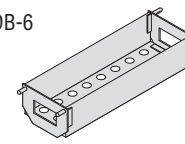

DB-12



# LABORATORY PEGBOARD SYSTEMS PEGS

## PEGS

MODEL NO.	DESCRIPTION	SHIPPING WT.	RETAIL PRICE
LP-12"	12" Long Peg	1 lbs.	3.00
LP-9"	9" Long Peg	1 lbs.	3.00
TP-4"	4" Tube Peg	1 lbs.	3.00
BP-6"	6" Bottle Peg	1 lbs.	3.00
PE-3"	3" Peg Extender	1 lbs.	3.00
HP-1	Hole Plug	1 lbs.	3.00
SP-4	4" Support Peg	1 lbs.	3.00

## COLOR PEGS

LLP-6"	Lilac Peg	1 lbs.	3.00
WPB-6"	Light Blue Peg	1 lbs.	3.00
LYP-6"	Yellow Peg	1 lbs.	3.00
LGP-6"	Green Peg	1 lbs.	3.00
HPP-6"	Pink Peg	1 lbs.	3.00
CRP-6"	Red Peg	1 lbs.	3.00
PPP-6"	Purple Peg	1 lbs.	3.00
HOP-6"	Orange Peg	1 lbs.	3.00
OBP-6"	Dark Blue Peg	1 lbs.	3.00
VBP-6"	Black Peg	1 lbs.	3.00
ACP-6"	Assorted Colored Pegs	1 lbs.	3.00

## TWO PRONG PEGS

EP-5	5.5" Two Prong Peg	1 lbs.	3.00
EP-6	6.5" Two Prong Peg	1 lbs.	3.00
EP-8	8.5" Two Prong Peg	1 lbs.	3.00

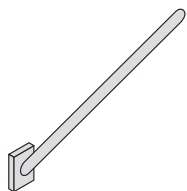

LP-12 Long Peg

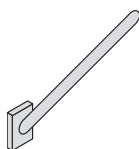

LP-9 Medium Peg



TP-4 Tube Peg

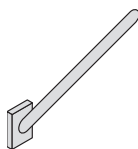

BP-6 Bottle Peg



PE-3 Peg Extender

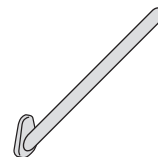















EP-5 Two Prong Peg



HP-1 Peg Hole Filler

To easily help customize your Mod-rack pegboard, we've created functional package options that include some of our most popular accessories.

ACCESSORY PRE-PACKS

MODEL NO.	SIZE WxH	NUMBER OF PEGS	RETAIL PRICE	COMPLETE WITH
V1824/PKG	18" x 24"	15	398.00	
V2418/PKG	24" x 18"	16	420.00	
V2424/PKG	24" x 24"	20	471.00	
V2430/PKG	24" x 30"	32	491.00	
V2436/PKG	24" x 36"	40	645.00	
V3024/PKG	30" x 24"	25	603.00	
V3030/PKG	30" x 30"	50	607.00	
V3036/PKG	30" x 36"	40	637.00	
V3624/PKG	36" x 24"	30	635.00	
V3630/PKG	36" x 30"	60	665.00	
V3636/PKG	36" x 36"	66	749.00	
V4824/PKG	48" x 24"	40	801.00	 Multiple Size Pegs
V4830/PKG	48" x 30"	48	917.00	 Multiple Size Pegs
V4836/PKG	48" x 36"	88	1055.00	 Multiple Size Pegs

## FACE & PEGBOARD MOUNTED DRIP TROUGHS

### FACE MOUNTED DRIP TROUGHS

All models are available 2" and 4" deep.  
Trough comes with drain tubing.

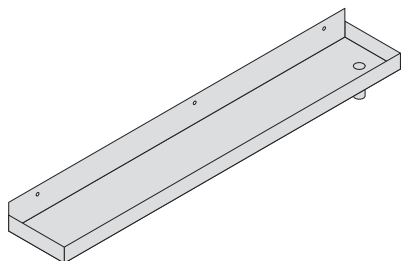

MODEL NO.	DIMENSION	SHIPPING WT.	RETAIL PRICE
FDT-18-2	18" x 2"	2 lbs.	66.00
FDT-18-4	18" x 4"	2 lbs.	66.00
FDT-20-2	20" x 2"	2 lbs.	69.00
FDT-20-4	20" x 4"	2 lbs.	69.00
FDT-24-2	24" x 2"	3 lbs.	72.00
FDT-24-4	24" x 4"	3 lbs.	72.00
FDT-30-2	30" x 2"	4 lbs.	76.00
FDT-30-4	30" x 4"	4 lbs.	76.00
FDT-32-2	32" x 2"	4 lbs.	78.00
FDT-32-4	32" x 4"	4 lbs.	78.00
FDT-36-2	36" x 2"	4 lbs.	80.00
FDT-36-4	36" x 4"	4 lbs.	80.00
FDT-42-2	42" x 2"	5 lbs.	84.00
FDT-42-4	42" x 4"	5 lbs.	84.00
FDT-48-2	48" x 2"	5 lbs.	90.00
FDT-48-4	48" x 4"	5 lbs.	90.00

### STAINLESS DRIP TROUGHS

All models are available 2" and 4" deep.  
Trough comes with drain tubing.

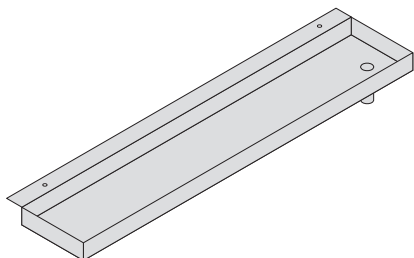

MODEL NO.	PRICE UNDER 25	PRICE OVER 25	PRICE OVER 100	PRICE OVER 300	MSRP
HDT-18-2	37.00	33.30	31.65	30.05	66.00
HDT-18-4	37.00	33.30	31.65	30.05	66.00
HDT-20-2	39.00	35.10	33.35	31.70	69.00
HDT-20-4	39.00	35.10	33.35	31.70	69.00
HDT-24-2	40.50	36.45	34.65	32.90	72.00
HDT-24-4	40.50	36.45	34.65	32.90	72.00
HDT-30-2	43.00	38.70	36.80	34.95	76.00
HDT-30-4	43.00	38.70	36.80	34.95	76.00
HDT-32-2	44.00	39.60	37.65	35.75	78.00
HDT-32-4	44.00	39.60	37.65	35.75	78.00
HDT-36-2	46.00	41.40	39.35	37.35	80.00
HDT-36-4	46.00	41.40	39.35	37.35	80.00
HDT-42-2	50.50	45.45	43.20	41.00	84.00
HDT-42-4	50.50	45.45	43.20	41.00	84.00
HDT-48-2	55.00	49.50	47.00	44.65	90.00
HDT-48-4	55.00	49.50	47.00	44.65	90.00
HDT-60-2	68.00	62.50	60.00	57.65	102.00
HDT-60-4	68.00	62.50	60.00	57.65	102.00

\* Model numbers can be mixed to gain quantity pricing advantage.

Screen inserts and drain grids for Mod-Rack™ pegboards, FDT drip troughs and HDT drip troughs, both 2" and 4" wide. Please add SI (screen insert) or DG (drain grid) in front of the model number. Ex; SI-18-2 or DG-18-2

**SCREEN INSERTS & DRAIN GRIDS**

MODEL NO.	DIMENSIONS	DESCRIPTION	SHIPPING WT.	RETAIL PRICE
SI or DG-18-2	18" x 2"	Screen Insert or Drain Grid	2 lbs.	48.00
SI or DG-18-4	18" x 4"	Screen Insert or Drain Grid	2 lbs.	48.00
SI or DG-20-2	20" x 2"	Screen Insert or Drain Grid	2 lbs.	51.00
SI or DG-20-4	20" x 4"	Screen Insert or Drain Grid	2 lbs.	51.00
SI or DG-24-2	24" x 2"	Screen Insert or Drain Grid	2 lbs.	53.00
SI or DG-24-4	24" x 4"	Screen Insert or Drain Grid	2 lbs.	53.00
SI or DG-30-2	30" x 2"	Screen Insert or Drain Grid	2 lbs.	57.00
SI or DG-30-4	30" x 4"	Screen Insert or Drain Grid	2 lbs.	57.00
SI or DG-32-2	32" x 2"	Screen Insert or Drain Grid	2 lbs.	62.00
SI or DG-32-4	32" x 4"	Screen Insert or Drain Grid	2 lbs.	62.00
SI or DG-36-2	36" x 2"	Screen Insert or Drain Grid	3 lbs.	63.00
SI or DG-36-4	36" x 4"	Screen Insert or Drain Grid	3 lbs.	63.00
SI or DG-42-2	42" x 2"	Screen Insert or Drain Grid	3 lbs.	68.00
SI or DG-42-4	42" x 4"	Screen Insert or Drain Grid	3 lbs.	68.00
SI or DG-48-2	48" x 2"	Screen Insert or Drain Grid	3 lbs.	71.00
SI or DG-48-4	48" x 4"	Screen Insert or Drain Grid	3 lbs.	71.00

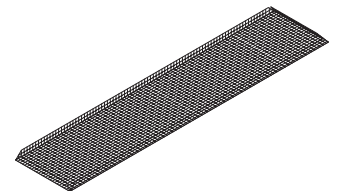

Screen Insert

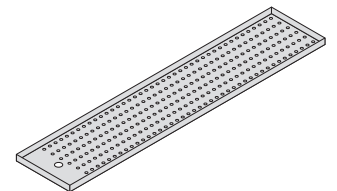

Drain Grid

**FINISHED BACKS**

MODEL NO.	DIMENSIONS	SHIPPING WEIGHT	RETAIL PRICE
FB-1824	18" x 24"	8 lbs.	104.00
FB-1830	18" x 30"	9 lbs.	104.00
FB-2418	24" x 18"	8 lbs.	104.00
FB-2424	24" x 24"	9 lbs.	104.00
FB-2430	24" x 30"	10 lbs.	173.00
FB-2436	24" x 36"	11 lbs.	173.00
FB-3024	30" x 24"	10 lbs.	173.00
FB-3030	30" x 30"	12 lbs.	218.00
FB-3624	36" x 24"	11 lbs.	173.00
FB-3630	36" x 30"	14 lbs.	218.00
FB-3636	36" x 36"	15 lbs.	218.00
FB-4824	48" x 24"	15 lbs.	245.00
FB-4830	48" x 30"	16 lbs.	245.00
FB-4836	48" x 36"	18 lbs.	245.00

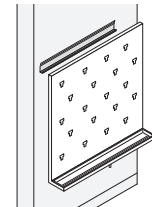

Wall Mount  
(ships with product)

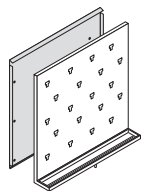

Finished Back

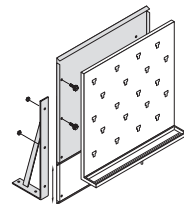

Free Standing Assembly

**FREE STANDING ASSEMBLY BRACKETS**

FSA	8" x 23"	11 lbs.	91.00
-----	----------	---------	-------

**RAISED TOP ASSEMBLY**

RTA			Call for pricing
-----	--	--	------------------

**WALL STANDARD MOUNT**

AHB-4	4 clips spot welded to pegboard for shelf standard mounting	37.50	25.00
-------	---	-------	-------

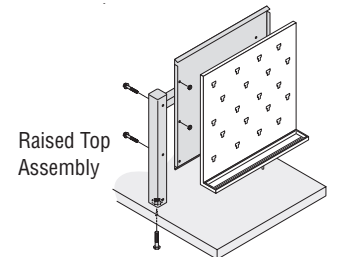

Raised Top Assembly

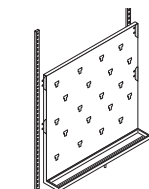

Wall Standard Assembly

## STAINLESS STEEL CARBOY SHELVES

This unique shelf system will adapt to not only the Inter Dyne Systems stainless steel pegboards but also existing acrylic, epoxy, stone or wood pegboards as well. This unit is manufactured from #304 stainless steel with a #4 finish.

Each shelf is manufactured with a rail system on the underside for support. These units, if requested, can also be supplied with an adjustable graduated cylinder racking system. This system adds our "C" and "H" brackets which allows you to customize the rack to your needs. The unit comes 12" or 16" deep to allow for storage.

### CARBOY SHELVES

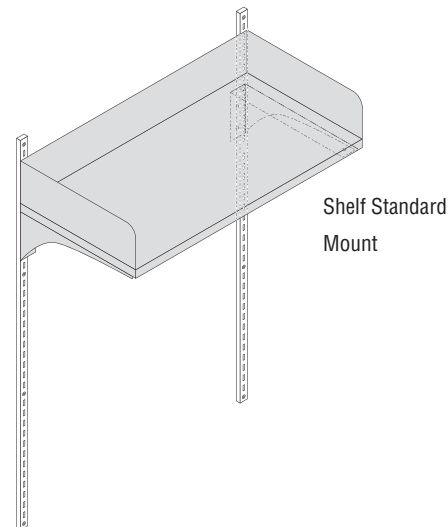
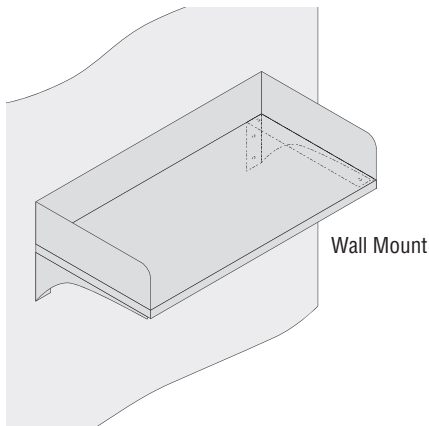
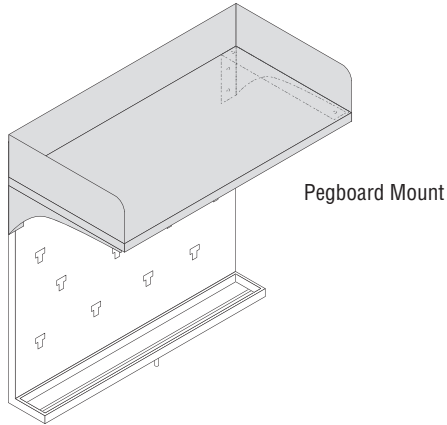

MODEL NO.	DIMENSION	RETAIL PRICE
CS-18-P-12	18" x 12"	211.00
CS-18-P-16	18" x 16"	221.00
CS-20-P-12	20" x 12"	220.00
CS-20-P-16	20" x 16"	230.00
CS-24-P-12	24" x 12"	228.00
CS-24-P-16	24" x 16"	241.00
CS-30-P-12	30" x 12"	247.00
CS-30-P-16	30" x 16"	263.00
CS-32-P-12	32" x 12"	225.00
CS-32-P-16	32" x 16"	242.00
CS-36-P-12	36" x 12"	271.00
CS-36-P-16	36" x 16"	291.00
CS-48-P-12	48" x 12"	315.00
CS-48-P-16	48" x 16"	336.00

### WALL MOUNT

CS-18-W-12	18" x 12"	211.00
CS-18-W-16	18" x 16"	221.00
CS-20-W-12	20" x 12"	220.00
CS-20-W-16	20" x 16"	230.00
CS-24-W-12	24" x 12"	228.00
CS-24-W-16	24" x 16"	241.00
CS-30-W-12	30" x 12"	247.00
CS-30-W-16	30" x 16"	263.00
CS-32-W-12	32" x 12"	225.00
CS-32-W-16	32" x 16"	242.00
CS-36-W-12	36" x 12"	271.00
CS-36-W-16	36" x 16"	291.00
CS-48-W-12	48" x 12"	315.00
CS-48-W-16	48" x 16"	336.00

### SHELF STANDARD MOUNT

CS-18-S-12	18" x 12"	211.00
CS-18-S-16	18" x 16"	221.00
CS-20-S-12	20" x 12"	220.00
CS-20-S-16	20" x 16"	230.00
CS-24-S-12	24" x 12"	228.00
CS-24-S-16	24" x 16"	241.00
CS-30-S-12	30" x 12"	247.00
CS-30-S-16	30" x 16"	263.00
CS-32-S-12	32" x 12"	225.00
CS-32-S-16	32" x 16"	242.00
CS-36-S-12	36" x 12"	271.00
CS-36-S-16	36" x 16"	291.00
CS-48-S-12	48" x 12"	315.00
CS-48-S-16	48" x 16"	336.00

## STAINLESS STEEL CARBOY SHELVES, ADJUSTABLE RACKING SYSTEM KIT

### DLX GRADUATED CYLINDER RACK

SIZE	NUMBER OF BRACKETS	RETAIL PRICE
18"	5	61.00
20"	6	73.50
24"	6	75.00
30"	7	87.00
32"	7	88.50
36"	8	100.50
48"	9	112.50

By simply adding the suffix "-DLX" to your desired shelf, it will come complete with an adjustable graduated cylinder rack mounted underneath.

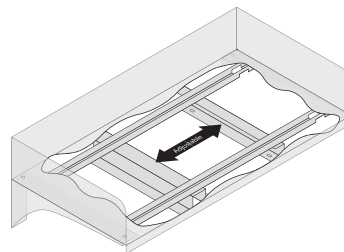

### ADJUSTABLE RACKING SYSTEM KIT

MODEL NO.	WIDTH	NUMBER OF CHANNEL BRACKETS	RETAIL PRICE
XP-18	18"	5	87.00
XP-20	20"	6	102.00
XP-24	24"	6	108.00
XP-30	30"	7	129.00
XP-32	32"	7	132.00
XP-36	36"	7	150.00
XP-48	48"	9	180.00

Use this to add an adjustable graduated cylinder rack to your existing acrylic, epoxy or wood shelving.

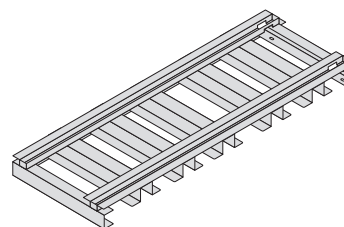

\*Designed to fit 12" shelves. For 16" deep shelves, add 5%.

## STAINLESS STEEL WALL SHELVES

### WALL SHELVES: 12" DEEP

MODEL NO.	DIMENSIONS	RETAIL PRICE
WS-1812	18"w x 12"d	48.00
WS-2412	24"w x 12"d	56.00
WS-3012	30"w x 12"d	73.00
WS-3612	36"w x 12"d	81.00
WS-4812	48"w x 12"d	97.00
WS-6012	60"w x 12"d	114.00
WS-7212	72"w x 12"d	133.00

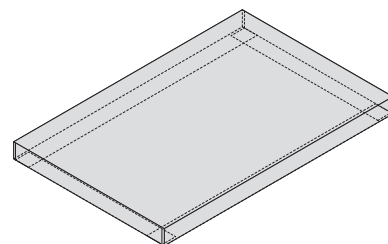

### WALL SHELVES: 16" DEEP

MODEL NO.	DIMENSIONS	RETAIL PRICE
WS-1816	18"w x 16"d	53.00
WS-2416	24"w x 16"d	69.00
WS-3016	30"w x 16"d	81.00
WS-3616	36"w x 16"d	95.00
WS-4816	48"w x 16"d	103.00
WS-6016	60"w x 16"d	136.00
WS-7216	72"w x 16"d	161.00

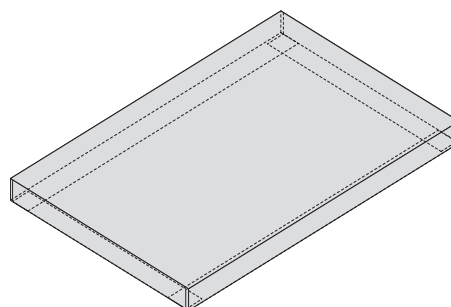

## STAINLESS STEEL WALL SHELVES

### WALL SHELVES WITH SEISMIC LIP: 12" DEEP

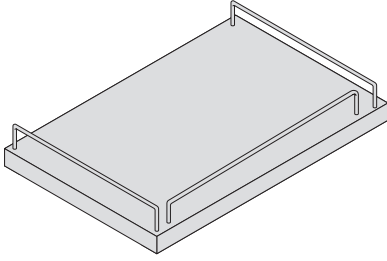

MODEL NO.	DIMENSIONS	RETAIL PRICE
WS-1812-SL	18" w x 12" d	84.00
WS-2412-SL	24" w x 12" d	95.00
WS-3012-SL	30" w x 12" d	108.00
WS-3612-SL	36" w x 12" d	121.00
WS-4812-SL	48" w x 12" d	150.00
WS-6012-SL	60" w x 12" d	180.00
WS-7212-SL	72" w x 12" d	215.00

### WALL SHELVES WITH SEISMIC LIP: 16" DEEP

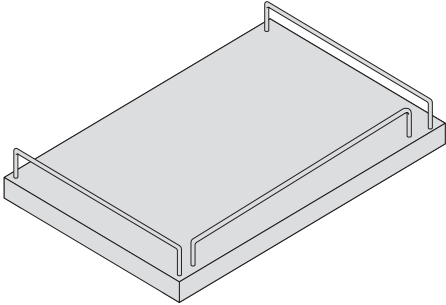

MODEL NO.	DIMENSIONS	RETAIL PRICE
WS-1816-SL	18" w x 16" d	94.00
WS-2416-SL	24" w x 16" d	109.00
WS-3016-SL	30" w x 16" d	118.00
WS-3616-SL	36" w x 16" d	142.00
WS-4816-SL	48" w x 16" d	171.00
WS-6016-SL	60" w x 16" d	205.00
WS-7216-SL	72" w x 16" d	244.00

### SEISMIC LIP

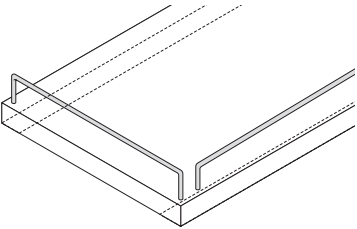

MODEL NO.	DIMENSIONS	RETAIL PRICE
SL-11	11" w x 2" h x 1/4" diam.	12.00
SL-14	14" w x 2" d x 1/4" diam.	13.00
Custom sizes also available, call for pricing.		
Turrets available.		
3/8" diameter also available.		

### WALL SHELVES WITH WRAPAROUND: 12" DEEP

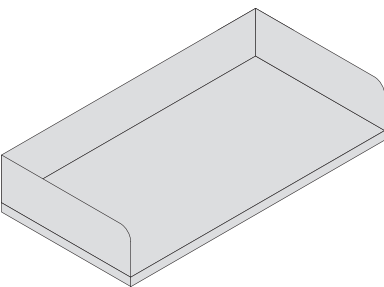

MODEL NO.	DIMENSIONS	RETAIL PRICE
WS-1812-WA	18" w x 12" d	84.00
WS-2412-WA	24" w x 12" d	95.00
WS-3012-WA	30" w x 12" d	108.00
WS-3612-WA	36" w x 12" d	121.00
WS-4812-WA	48" w x 12" d	150.00
WS-6012-WA	60" w x 12" d	180.00
WS-7212-WA	72" w x 12" d	215.00

### WALL SHELVES WITH WRAPAROUND: 16" DEEP

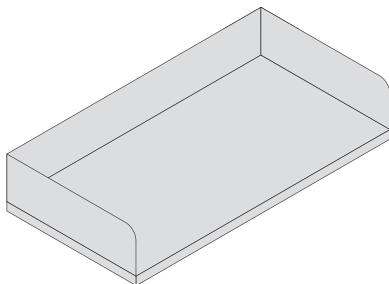

MODEL NO.	DIMENSIONS	RETAIL PRICE
WS-1816-WA	18" w x 16" d	97.00
WS-2416-WA	24" w x 16" d	112.00
WS-3016-WA	30" w x 16" d	129.00
WS-3616-WA	36" w x 16" d	147.00
WS-4816-WA	48" w x 16" d	178.00
WS-6016-WA	60" w x 16" d	216.00
WS-7216-WA	72" w x 16" d	261.00

**STAINLESS STEEL WALL STANDARDS  
STAINLESS STEEL BRACKETS  
STAINLESS STEEL WALL BRACKETS**

**WALL MOUNT SINGLE SLOT STANDARD**

MODEL NO.	DIMENSIONS	RETAIL PRICE
SS-2FT	2 ft.	16.50
SS-2.5FT	2.5 ft.	18.50
SS-3FT	3 ft.	20.00
SS-3.5FT	3.5 ft.	21.75
SS-4FT	4 ft.	23.25
SS-6FT	6 ft.	30.00



**WALL MOUNT DOUBLE SLOT STANDARD**

MODEL NO.	DIMENSIONS	RETAIL PRICE
SSD-2FT	2 ft.	31.50
SSD-2.5FT	2.5 ft.	35.25
SSD-3FT	3 ft.	38.25
SSD-3.5FT	3.5 ft.	40.75
SSD-4FT	4 ft.	44.25
SSD-6FT	6 ft.	57.00



**SINGLE SLOT BRACKET**

MODEL NO.	DIMENSIONS	RETAIL PRICE
SB-12-L	12"	15.00
SB-12-R	12"	15.00
SB-16-L	16"	18.00
SB-16-R	16"	18.00
SB-18-L	18"	25.00
SB-18-R	18"	25.00

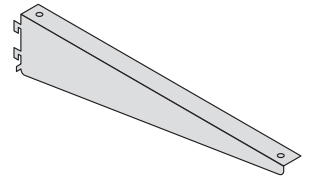

**DOUBLE SLOT BRACKET**

MODEL NO.	DIMENSIONS	RETAIL PRICE
SBD-12	12"	25.50
SBD-16	16"	32.00
SBD-18	18"	37.50

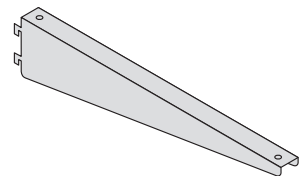

**BOOKEND BRACKET**

MODEL NO.	DIMENSIONS	RETAIL PRICE
SBB-12-L	12"	28.50
SBB-12-R	12"	28.50
SBB-16-L	16"	34.50
SBB-16-R	16"	34.50
SBB-18-L	18"	40.50
SBB-18-R	18"	40.50

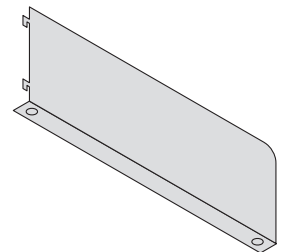

**WALL MOUNT BRACKET**

MODEL NO.	DIMENSIONS	RETAIL PRICE
WMB-12	12"	18.00
WMB-16	16"	22.50
WMB-18	18"	30.00

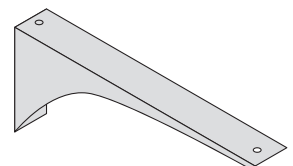

# HEAVY DUTY STAINLESS STEEL WALL STANDARDS (12 GAUGE) STAINLESS STEEL BRACKETS STAINLESS STEEL WALL BRACKETS

## WALL MOUNT SINGLE SLOT STANDARD



MODEL No.	DIMENSIONS	RETAIL PRICE
HD-SS-2FT	2 ft.	19.50
HD-SS-2.5FT	2.5 ft.	22.50
HD-SS-3FT	3 ft.	24.00
HD-SS-3.5FT	3.5 ft.	27.25
HD-SS-4FT	4 ft.	29.25
HD-SS-6FT	6 ft.	39.00

## WALL MOUNT DOUBLE SLOT STANDARD



MODEL No.	DIMENSIONS	RETAIL PRICE
HD-SSD-2FT	2 ft.	36.00
HD-SSD-2.5FT	2.5 ft.	41.00
HD-SSD-3FT	3 ft.	44.25
HD-SSD-3.5FT	3.5 ft.	50.25
HD-SSD-4FT	4 ft.	53.25
HD-SSD-6FT	6 ft.	70.50

## SINGLE SLOT BRACKET

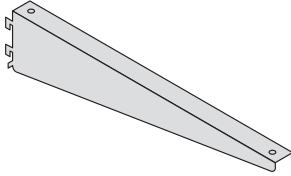

MODEL No.	DIMENSIONS	RETAIL PRICE
HD-SB-12-L	12"	18.00
HD-SB-12-R	12"	18.00
HD-SB-16-L	16"	23.50
HD-SB-16-R	16"	23.50
HD-SB-18-L	18"	30.00
HD-SB-18-R	18"	30.00

## DOUBLE SLOT BRACKET

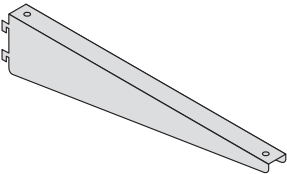

MODEL No.	DIMENSIONS	RETAIL PRICE
HD-SBD-12	12"	31.50
HD-SBD-16	16"	40.00
HD-SBD-18	18"	46.50

## BOOKEND BRACKET

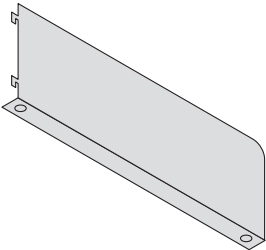

MODEL No.	DIMENSIONS	RETAIL PRICE
HD-SBB-12-L	12"	33.00
HD-SBB-12-R	12"	33.00
HD-SBB-16-L	16"	40.50
HD-SBB-16-R	16"	40.50
HD-SBB-18-L	18"	47.25
HD-SBB-18-R	18"	47.25

## WALL MOUNT BRACKET

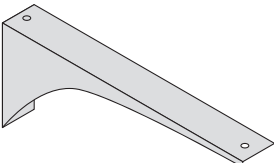

MODEL No.	DIMENSIONS	RETAIL PRICE
HD-WMB-12	12"	25.50
HD-WMB-16	16"	33.00
HD-WMB-18	18"	42.00

Posts and shelf brackets are all constructed from 14 gauge material. Stringers are constructed from 16 gauge material.

**POSTS**

MODEL NO.	DIMENSIONS	RETAIL PRICE
DP-48	Painted steel 48" high table top post	212.00
DPS-48	Stainless steel 48" high table top post	314.00
DP-84	Painted steel 84" high table top post	257.00
DPS-84	Stainless steel 48" high table top post	352.00

Each post comes with a mounting bracket for either floor (84" post) or counter top (48" post) application.

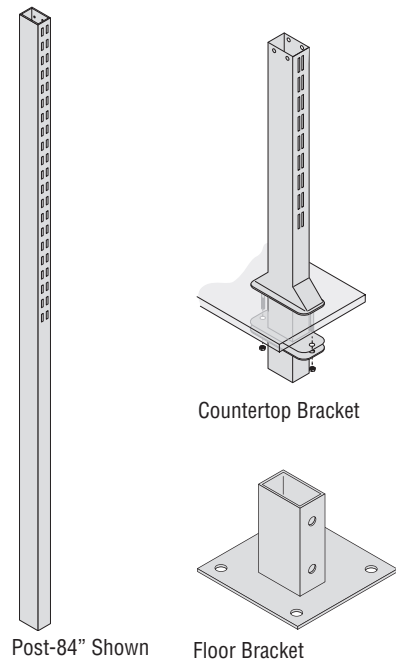

MODEL NO.	DIMENSIONS	RETAIL PRICE
DS-28	Painted steel 28" wide stringer	28.50
DSS-28	Stainless steel 28" wide stringer	37.50
DS-34	Painted steel 34" wide stringer	30.75
DSS-34	Stainless steel 34" wide stringer	40.50
DS-46	Painted steel 46" wide stringer	37.50
DSS-46	Stainless steel 46" wide stringer	49.50

**STRINGERS**

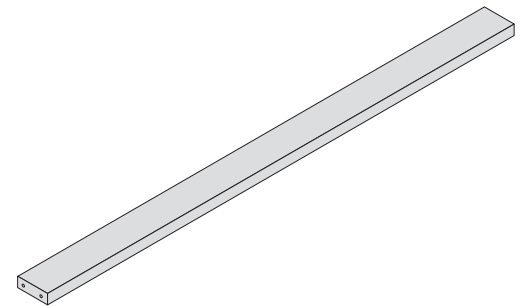

MODEL NO.	DIMENSIONS	RETAIL PRICE
DB-12L	Painted 12" left bracket	24.50
DB-12R	Painted 12" right bracket	24.50
DBS-12L	Stainless steel 12" left bracket	31.50
DBS-12R	Stainless steel 12" right bracket	31.50

**SHELF BRACKETS**

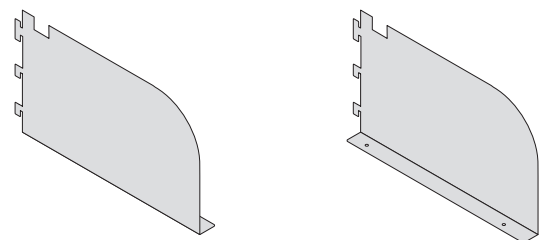

**NAR-LOCK NARCOTIC CABINETS  
 MED-LOCK DRAWER UNITES  
 SPECIMEN PASS-THRU BOXES**

**DOUBLE KEY LOCK CABINET**

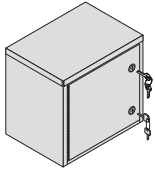

MODEL NO.	DIMENSIONS	SHIPPING WT.	RETAIL PRICE
NL-2K	12"h x 13"w x 10"d	20 lbs.	555.00
NL-2K-D	12"h x 21"w x 10"d	29 lbs.	801.00

**COMBINATION LOCK CABINET**

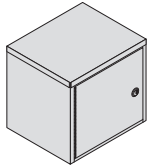

MODEL NO.	DIMENSIONS	SHIPPING WT.	RETAIL PRICE
NL-1C	12"h x 13"w x 10"d	21 lbs.	585.00
NL-1C-D	12"h x 21"w x 10"d	29 lbs.	831.00

**COMBINATION & KEY LOCK CABINET**

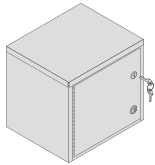

MODEL NO.	DIMENSIONS	SHIPPING WT.	RETAIL PRICE
NL-1CK	12"h x 13"w x 10"d	21 lbs.	585.00
NL-1CK-D	12"h x 21"w x 10"d	29 lbs.	831.00

**INNER & OUTER DOOR, EACH WITH CYLINDER LOCKS CABINET**

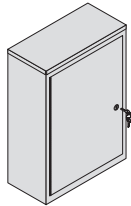

MODEL NO.	DIMENSIONS	SHIPPING WT.	RETAIL PRICE
NL-681	24"h x 16"w x 8"d	10 lbs.	960.00
MC-10-30	30"h x 18"w x 12"d	82 lbs.	1420.00
NL-501	9"h x 8"w x 5 5/8"d	8 lbs.	517.00
NL-651	15"h x 11"w x 8"d	15 lbs.	829.00

**OPTIONS**

MODEL NO.	DESCRIPTION	SHIPPING WT.	RETAIL PRICE
IL-1	Interior/Remote Warning Light	2 lbs.	35.00
KEY	Extra Set of Keys	1 lbs.	15.00
LOCK	Replacement Lock		45.00

**MED-LOCK DRAWER UNIT**

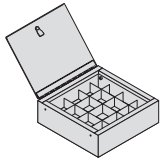

MODEL NO.	DIMENSIONS	SHIPPING WT.	RETAIL PRICE
DR-12	4"h x 12"w x 12"d	13 lbs.	375.00
LOCK-DR-12	Replacement Lock		90.00

**TURNTABLE SPECIMEN PASS BOX**

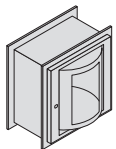

MODEL NO.	DIMENSIONS	SHIPPING WT.	RETAIL PRICE
0515	15 1/2"h x 14 3/4"w x 7"d Wall opening: 14"h x 13 1/4"w x 3 3/8" to 7" wall thickness	27 lbs.	1057.00

**TWO DOOR PASS THRU SPECIMEN BOX**

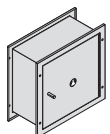

MODEL NO.	DIMENSIONS	SHIPPING WT.	RETAIL PRICE
8154	12 3/4"h x 13 1/4"w x 6"d Wall opening: 11 1/2"h x 11"w x 1 3/4" to 5" wall thickness	17 lbs.	492.00



- 
- Major credit cards accepted
  - All items priced are F.O.B. Norton Shores, MI
  - Terms are 1/10 days, net 30 days
  - Most items are stocked for quick shipment

These products are covered by one or more of the following patents.  
4,485,929: 3,912,212: 3,770,392: 5,163,567: 5,884,784

---



**INTER DYNE**  
SYSTEMS

---

**CONTACT US!**

**Inter Dyne Systems, Inc.**  
**676 E. Ellis Road**  
**Norton Shores, MI 49441**

---

**P: 877.4SS.LABS (477.5227)**

**F: 231.799.9690**

**E: [sales@interdynesystems.com](mailto:sales@interdynesystems.com)**

**W: [www.interdynesystems.com](http://www.interdynesystems.com)**

---