

# "FASG" Free-Standing Acrylic Splash Guard

Clear acrylic splash guard with two legs to hold it.

## Features

- 40"w x 15"h x 3/8"d
- 2 - 10"w x 12"h x 3/4"d legs
- Eased and flame polished edges

## Product Dimensions

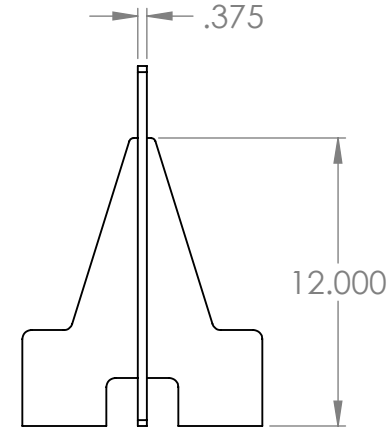
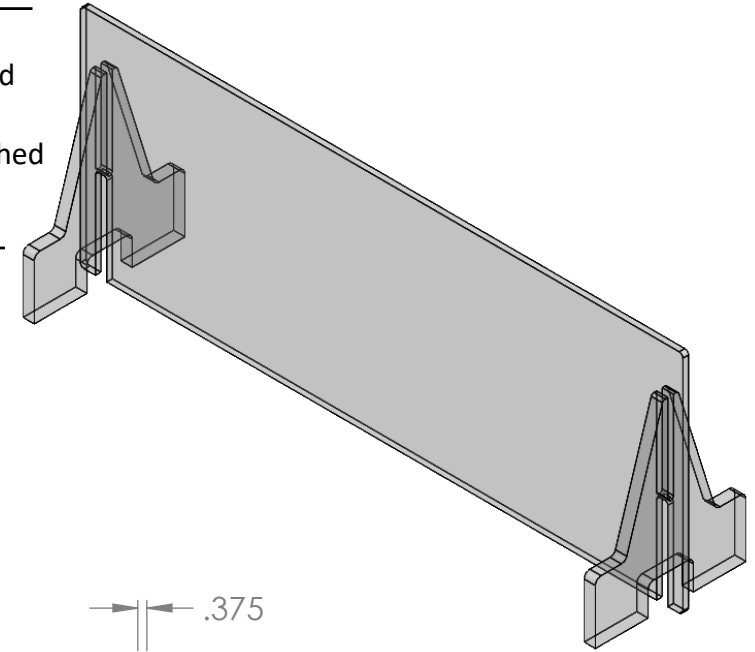
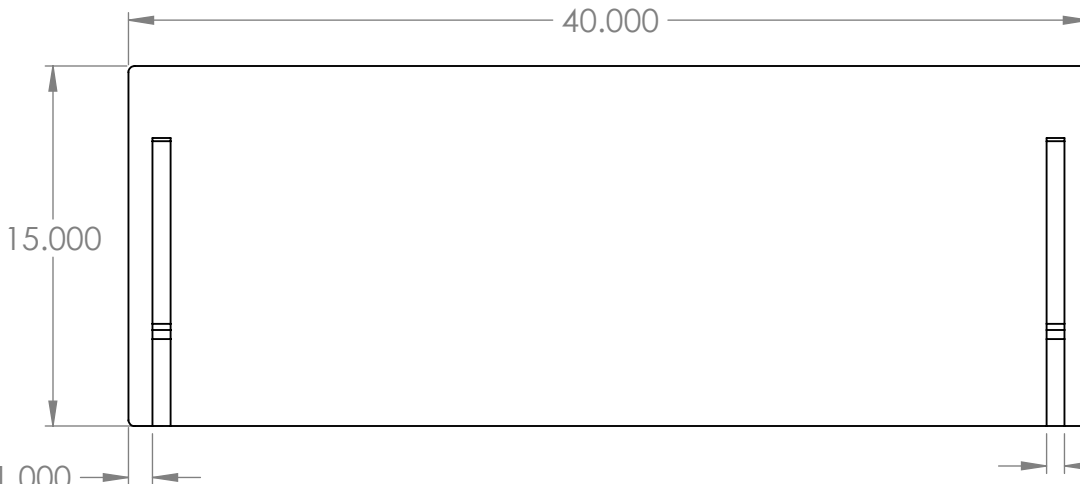

UNLESS OTHERWISE SPECIFIED:

DIMENSIONS ARE IN INCHES  
TOLERANCES:  
FRACTIONAL ±  
ANGULAR: MACH ± BEND ±  
TWO PLACE DECIMAL ±  
THREE PLACE DECIMAL ±

INTERPRET GEOMETRIC  
TOLERANCING PER:

MATERIAL  
**3/8" CLEAR ACRYLIC**  
FINISH  
**EDGES EASED & POLISH**

DO NOT SCALE DRAWING

	NAME	DATE
DRAWN	ASR	11/8/2018
CHECKED		
ENG APPR.		
MFG APPR.		
Q.A.		
COMMENTS:		

INTER DYNE SYSTEM, INC  
676 E.Ellis Rd., Norton Shores, MI 49441  
Phone: 231-799-8760 Fax: 231-799-9690

TITLE:

**FASG-4015**

SIZE	DWG. NO.	REV
<b>A</b>		
SCALE: 1:10	WEIGHT:	SHEET 1 OF 1

**PROPRIETARY AND CONFIDENTIAL**  
THE INFORMATION CONTAINED IN THIS DRAWING IS THE SOLE PROPERTY OF INTER DYNE SYSTEMS. ANY REPRODUCTION IN PART OR AS A WHOLE WITHOUT THE WRITTEN PERMISSION OF INTERDYNE SYSTEMS IS PROHIBITED.