

PRODUCT DIMENSIONS

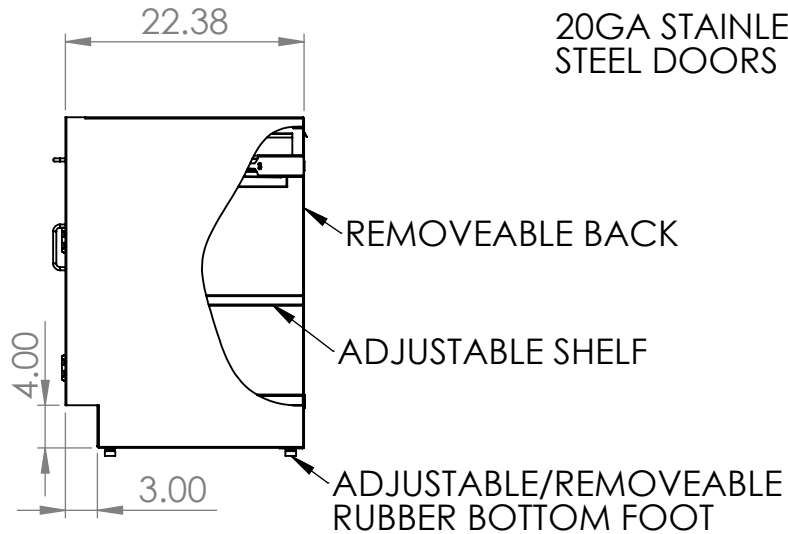
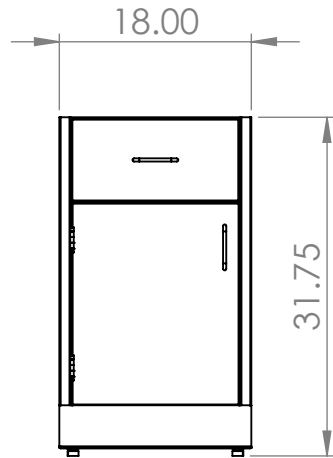

STAINLESS STEEL FULL EXT. DRAWER SLIDES WITH LEVER RELEASE

STAINLESS STEEL 5 KNUCKLE HINGES

STAINLESS STEEL 4IN WIRE PULL HANDLES

20GA STAINLESS STEEL DOORS

18GA STAINLESS STEEL CONST.

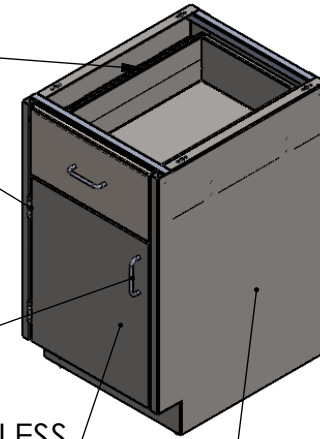

UNLESS OTHERWISE SPECIFIED:

DIMENSIONS ARE IN INCHES
TOLERANCES:
ANGULAR ±2.50°
ONE-PLACE ±0.5
TWO-PLACE ±0.13

PROPRIETARY AND CONFIDENTIAL

THE INFORMATION CONTAINED IN THIS DRAWING IS THE SOLE PROPERTY OF INTER DYNE SYSTEMS. ANY REPRODUCTION IN PART OR AS A WHOLE WITHOUT THE WRITTEN PERMISSION OF INTER DYNE SYSTEMS IS PROHIBITED.

REV.	REVISION DESCRIPTION	DRAWN	CHECKED	DATE	COMMENTS:
A	SUBMITTALS SENT	ASR		--/--/--	

QTY: N/A



INTER DYNE SYSTEMS, INC

676 E. Ellis Rd., Norton Shores, MI 49441
Phone: 231-799-8760 Fax: 231-799-9690

PART NO.

SBC3518-A-LH-ADA

MATERIAL: **18GA**

FINISH: **304 #4**