

"V" Victoria Series

V Series pegboards have a catch drain and integral drip trough in 2" or 4" depth. All drip troughs some with a 36" clear flexible drain tube.

Features

- 36"w x 30"h x 3/4"d
- 60-6" long 1/2" diameter white Polypropylene pegs
- Autoclavable
- Constructed from 20 gauge, type 304 stainless steel, polished to a #4 finish
- Wall mount bracket shipped with each pegboard

Product Dimensions

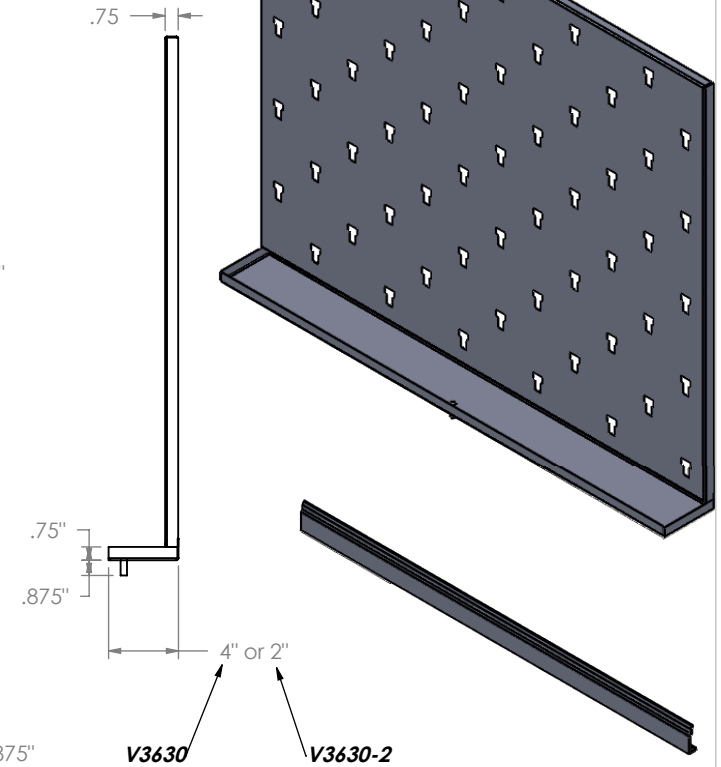
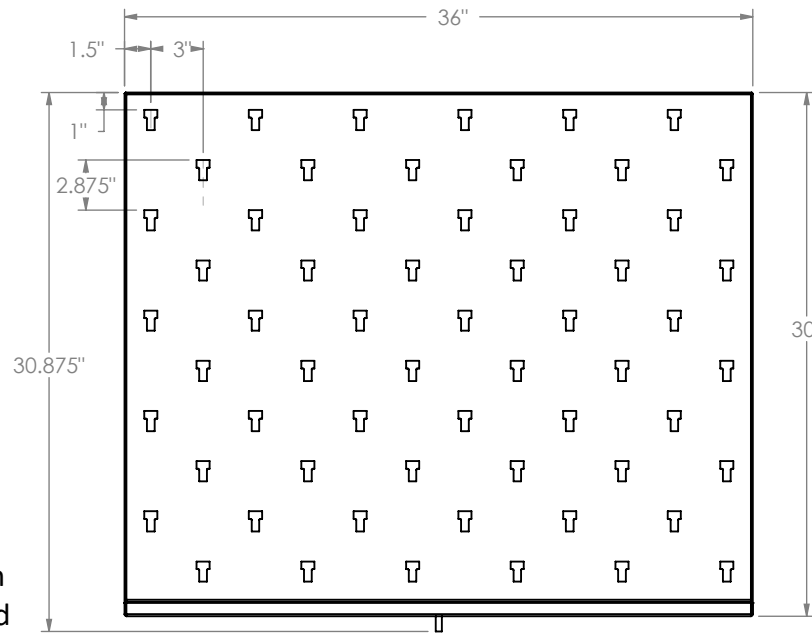

Wall Mount Bracket

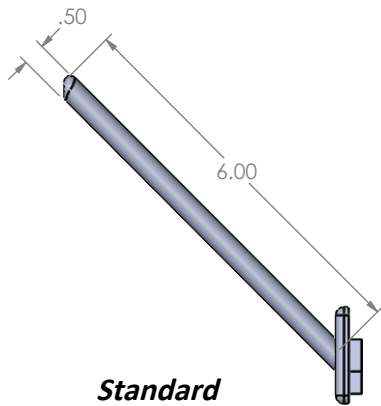

Standard Peg

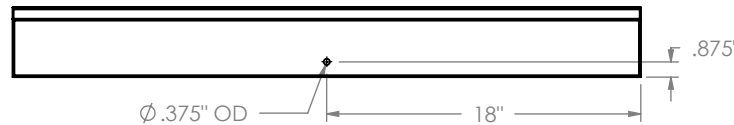

UNLESS OTHERWISE SPECIFIED:		NAME	DATE
DIMENSIONS ARE IN INCHES TOLERANCES: FRACTIONAL ± ANGULAR: MACH ± BEND ± TWO PLACE DECIMAL ± THREE PLACE DECIMAL ±	DRAWN	ASR	10/31/2018
	CHECKED		
	ENG APPR.		
	MFG APPR.		
INTERPRET GEOMETRIC TOLERANCING PER:	Q.A.		
MATERIAL STAINLESS STEEL 20 GA FINISH TYPE 304 #4	COMMENTS:		
DO NOT SCALE DRAWING			
INTER DYNE SYSTEM, INC 676 E.Ellis Rd., Norton Shores, MI 49441 Phone: 231-799-8760 Fax: 231-799-9690			
TITLE: V3630 / V3630-2			
SIZE A	DWG. NO.	REV	
SCALE: 1:20	WEIGHT:	SHEET 1 OF 1	

PROPRIETARY AND CONFIDENTIAL
THE INFORMATION CONTAINED IN THIS DRAWING IS THE SOLE PROPERTY OF INTER DYNE SYSTEMS. ANY REPRODUCTION IN PART OR AS A WHOLE WITHOUT THE WRITTEN PERMISSION OF INTERDYNE SYSTEMS IS PROHIBITED.