

"SCUL-3B-DLX" 3 BOWL SCULLERY DELUXE

Stainless steel scullery with 3 integral sink bowl and *optional Fixed or Removable Lower Shelf

Features

- 14GA Construction
- 2" x 2" Square Tubing Legs
- 1.5" x 1.5" Square Tubing Stretchers
- 4" Front & Side Aprons
- Adjustable Height Bullet Feet
- *Please see SCUL- or -RFD drawings for additional options

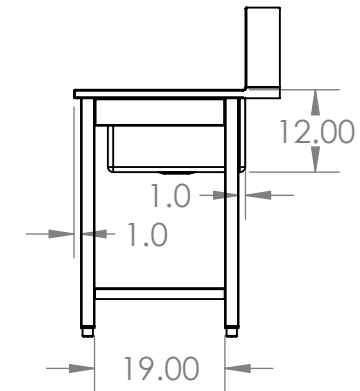
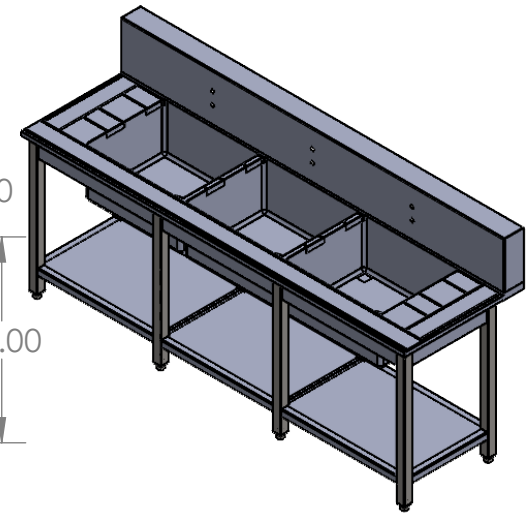
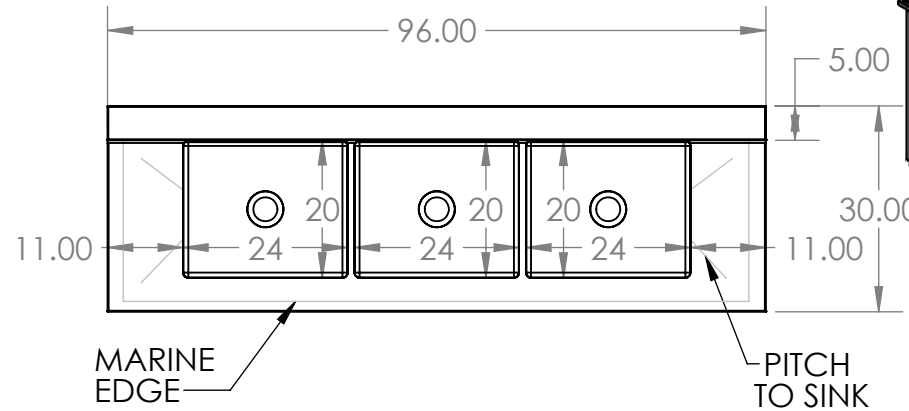

UNLESS OTHERWISE SPECIFIED:

DIMENSIONS ARE IN INCHES
TOLERANCES:
ANGULAR ±2.50°
ONE-PLACE ±0.5
TWO-PLACE ±0.13

PROPRIETARY AND CONFIDENTIAL

THE INFORMATION CONTAINED IN THIS DRAWING IS THE SOLE PROPERTY OF INTER DYNE SYSTEMS. ANY REPRODUCTION IN PART OR AS A WHOLE WITHOUT THE WRITTEN PERMISSION OF INTER DYNE SYSTEMS IS PROHIBITED.

REV.	REVISION DESCRIPTION	DRAWN	CHECKED	DATE	COMMENTS:
A	SUBMITTALS SENT	ASR		05/20/22	HAT CHANNEL AND SOUND DEADENER TO BE APPLIED IN FINAL ASSEMBLY
					QTY:



INTER DYNE SYSTEMS, INC

676 E. Ellis Rd., Norton Shores, MI 49441
Phone: 231-799-8760 Fax: 231-799-9690

PART NO.

SCUL-96-3B-DLX

MATERIAL: **14GA**

FINISH: **304 #4**