

Countertop with Frame

Stainless Steel Flat Countertop with
Stainless Steel Frame.

Features

- 48"l x 30"w x 1"t
- S/S - 2" x 2" square tubing legs
- S/S - 1.5" x 1.5" square tubing stretchers
- S/S - 4" Weld on Rails on all four sides
- 4 - Adjustable Bullet Feet
- Available in 24", 30" & 36" Depth
- *OPTIONAL*
S/S - Fixed/Removable Lower Shelf
- *OPTIONAL*
4" Locking Casters instead of bullet feet

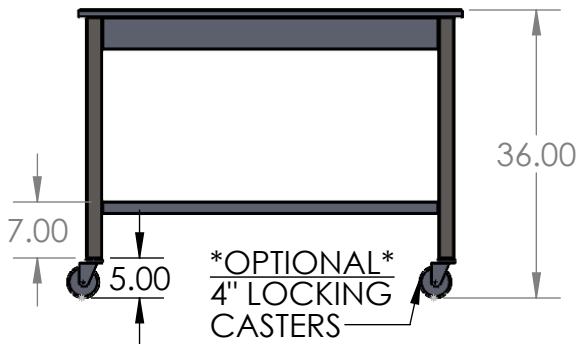

Product Dimensions

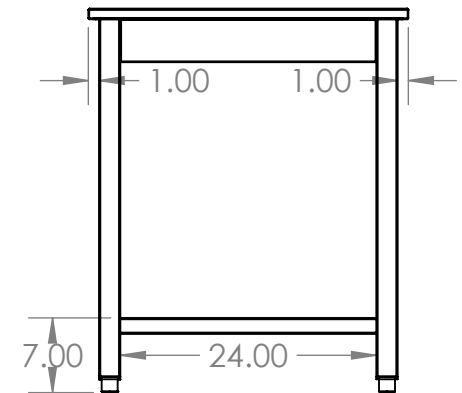
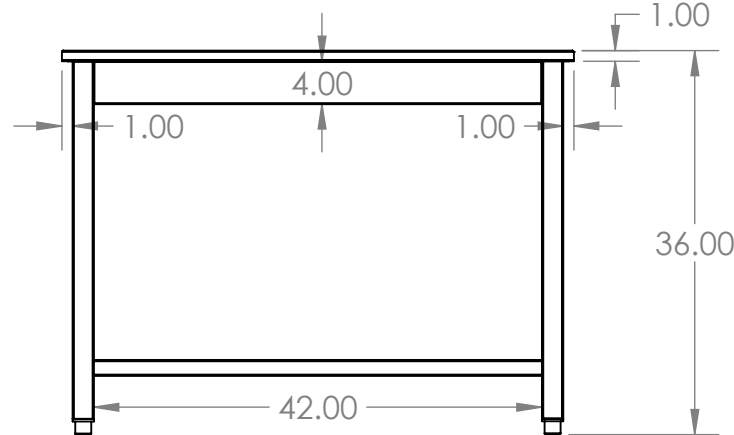
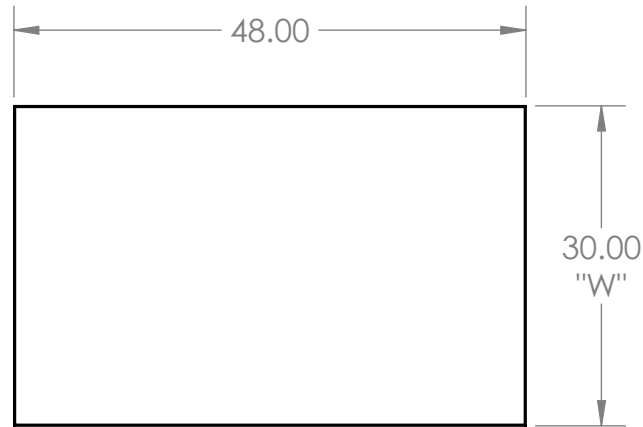

UNLESS OTHERWISE SPECIFIED:

DIMENSIONS ARE IN INCHES
TOLERANCES:
ANGULAR ±2.50°
ONE-PLACE ±0.5
TWO-PLACE ±0.13

PROPRIETARY AND CONFIDENTIAL

THE INFORMATION CONTAINED IN
THIS DRAWING IS THE SOLE
PROPERTY OF INTER DYNE SYSTEMS.
ANY REPRODUCTION IN PART OR
AS A WHOLE WITHOUT THE WRITTEN
PERMISSION OF INTER DYNE
SYSTEMS IS PROHIBITED.

REV.	REVISION DESCRIPTION	DRAWN	CHECKED	DATE	COMMENTS:
A	STANDARD PRINT CREATED	ASR		10/05/20	HAT CHANNEL AND SOUND DEADENER TO BE APPLIED IN FINAL ASSEMBLY
					QTY: N/A



**INTER DYNE
SYSTEMS, INC**

676 E. Ellis Rd., Norton Shores, MI 49441
Phone: 231-799-8760 Fax: 231-799-9690

PART NO.

48 X 30 X 1- CTOP & FRAME

MATERIAL: **16GA**

FINISH: **304**